

OWNER'S MANUAL



JET X

**PENGALAMAN
SEMPURNA**



1. CONTENTS

1. Contents	1
2. Control location	3
3. Before riding	4
4. Safe riding	4
5. Driving	5
6. Use genuine spare parts	5
7. Use of each component	6
Gauges	6
Operation of ignition switch	8
Operation of steering handle lock switch	8
Operation of seat open switch	8
Description of anti-theft intelligent lock (for Intelligent lock model)	9
Use of buttons	13
Storage box	14
Safety helmet hook	14
Fuel tank cap	15
Brake	15
Important points and cautions for starting engine	16
8. The best way to drive off	17
The control of throttle valve handle	17
Parking method	17
9. Inspection and maintenance before riding	18
Routine inspection	18
Engine oil inspection and change	18
Fuel inspection	19
Transmission oil inspection and change	19
Inspection and adjustment of brake free play	20
Throttle valve handle clearance adjustment	21
Inspection and maintenance of battery	21
Tire inspection	23
Steering handle front shock absorbers inspection	23
Checking and changing fuses	24
Checking the turn signal lights and horn	24
Checking the front and rear lights	24
Checking the brake light	24
Checking for fuel leakage	25

1. CONTENTS

Checking the lubrication of body's various mechanisms	25
Checking the spark plug	25
Checking the air cleaner	25
10. When there is an abnormal condition or a trouble	26
Diagnosis when engine does not start	26
11. Suggestions on engine fuel	26
12. Transmission oil	26
13. Cautions for riding scooter	27
Anti-lock brake system	28
TCS system	28
14. Cooling system inspection	29
15. Periodical maintenance schedule	31
16. Specification	33

2. CONTROL LOCATION

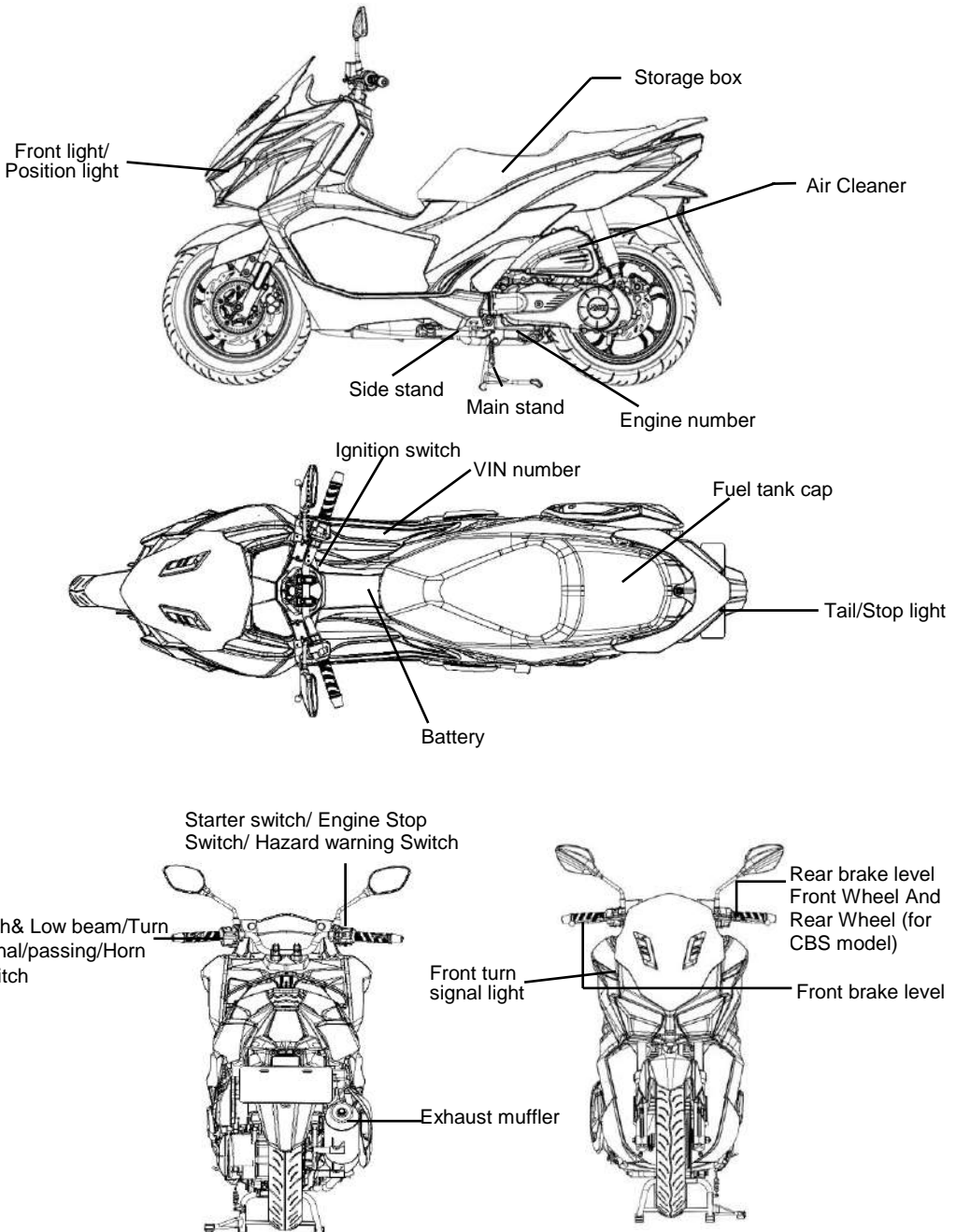

3. BEFORE RIDING

This manual describes the correct usage of this scooter including safety riding, simple inspection methods and so on.

For a more comfortable and safety riding, please read this manual carefully.

For your benefit, please ask your SANYANG dealer the operating manual and carefully read the following:

- Correct use of the motorcycle.
- Pre-delivery inspection and maintenance.

Thank you very much for your patronage

In order to maximize your motorcycle's performance, a periodical inspection and maintenance should be completely carried out.

We recommend that after riding your new motorcycle for the first 300 kilometers, you should take your motorcycle to the original dealer for an initial inspection, and to have your motorcycle inspected periodically every 1000 kilometers thereafter.

- In case the scooter's specifications and construction are modified and different from the photos and diagrams on the owner's manual / catalogues, the specifications and construction of the actual scooter shall prevail.

3. SAFE RIDING

It is very important to be relax and clothe properly when driving, observe traffic regulations, do not rush, always drive carefully and relaxed.

Usually, most people would ride their newly bought scooter very carefully, but after they became familiar with their scooters, they tended to become reckless which may result in an accident.



To remind you:

- Please wear a safety helmet, and properly tighten the chin belt when riding a motorcycle.
- Clothes with open or loose cuffs may be blown by wind and cause the cuffs to get caught on the steering handle and thus affects riding safety.
- So, put on clothes with tight sleeves.
- Hold the steering handle by both hands when riding. Never ride with only one hand.
- Observe the speed limit.
- Wear suitable low-heel shoes.
- **Perform periodical maintenance and inspection in accordance with the schedule.**



WARNING!!

- To avoid getting burned by exhaust pipe when taking a passenger. Make sure your passenger has put his/her feet on the pedals.
- After running, the exhaust pipe is very hot, be careful not to get burned when conducting an inspection or maintenance.
- After running, the exhaust pipe is very hot, select a suitable location to park your scooter to avoid others getting burned by the exhaust pipe.



CAUTION:

Modified motorcycle will affect its structure or performance, and cause poor engine operation or exhaust noise, which will result in shortening the motorcycle's service life.

Besides, modification is illegal and does not conform to the original design and specifications.

A modified motorcycle will not be covered by warranty, therefore, do not modify your motorcycle at will.

4. DRIVING

- **Keep the related parts of your body such as arms, palms, lumbar, and toes relax and ride with the most comfortable posture in order to be able to react quickly whenever it is necessary.**
- Rider's posture will greatly affect riding safety. Always keep your body's gravity in the center of the saddle, if your body's gravity is on the rear part of saddle, the front wheel load will be reduced, and this will cause the steering handle shaking. It is dangerous to ride a scooter with an unstable handle.
- It will be much easier to make a turn if rider inclines his body inward when turning. On the other hand, the rider will feel unstable if his body and the scooter do not incline.
- The scooter is hard to control on a bumpy, unlevelled, unpaved road, try to know the road conditions in advance, slow down and use your shoulder's force to control the handle.
- Suggestion: Do not load objects on the front pedals unnecessarily, to avoid affecting the riding safety and the operation of steering handle.

CAUTION:

The rider's feeling on the handle is slightly different with a load or without a load. Overload may cause the handle to swing and affects the riding safety. Therefore, do not overload your scooter.

CAUTION:

- Do not place flammable materials such as rags between the body side cover and engine to avoid components damaging by fire.
- Do not load objects on areas not specified for loading to avoid damage.

SUGGESTION

To maximize the motorcycle's performance and prolong its service life:
The first month or first 1000km is the wear- in period for the engine and components.
Avoid rapid acceleration, and keep the speed below 60km/hr.

5. USE GENUINE SPARE PARTS

In order to maintain the scooter's best performance, each part's quality, material, and machined precision must conform with the design requirements. **"SYM Genuine Spare Parts"** were made from the same high quality materials used for the original scooter. No parts would be sold to the market until they could meet the designed specifications through sophisticated engineering and stringent quality control. Therefore, it is necessary to purchase **"SYM Genuine Spare Parts"** from **"SYM Authorized Dealers or Franchised Dealers"** when replacing spare parts. If you buy cheap, or fake substitute parts from the market, no guarantee can be provided either for the quality or durability. Also, it may result in unexpected troubles and lower the scooter's performance.

- Always use **SYM Genuine Spare Parts** to keep your scooters pure blood and to ensure its long service life.

6. USE OF EACH COMPONENT

(The following is SYM 4 stroke scooter's basic operation, and they could vary from different individual models. Please consult the end of this manual.)

§GAUGES §

The panel figure for speedometer may vary from model to model, but the location usually is the same.

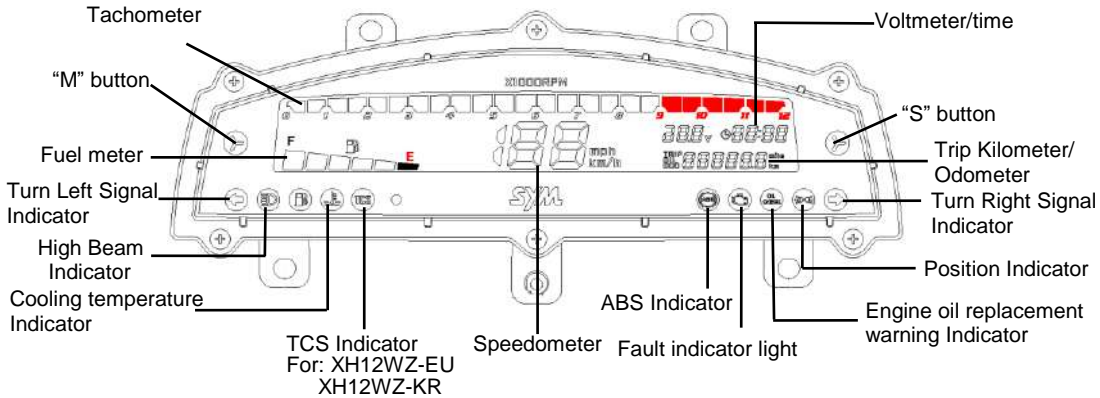

CAUTION:

Do not wipe plastic components, e.g. instrument panel, headlight, with organic solvents such as gasoline...etc to avoid damaging these components.

- **Speedometer/ Tachometer :**
Indicates driving speed or engine rpm.
- **Odometer:**
Indicates total accumulated distance traveled.
- **Trip Kilometer:**
The rider can measure the trip kilometers.
In normal display status, press "MODE" button for 1second, it can show total distance traveled.
Press "MODE" button again, then it can be switching over trip kilometer display mode.
In trip kilometer display status, press "SET" button for a long time, it can eliminate the mileage value.
- **High Beam Indicator :**
This indicator comes on with high beam headlight is turned on.
- **Turn (left/right) Signal Indicator :**
The left or right Indicator will be flashing according to the operated directions of turn signal light switch when it is turned on.
- **Fuel Meter:**
The pointer in this meter shows how much fuel remains in the tank.
The pointer stays in "E" position when key switch is turned to "OFF".
- **Cooling temperature indicator (For: water- cooling model):**
Indicates the engine cooling water temperature, engine cooling water temperature indicator if light, should check the cooling water is sufficient and the fan motor is running.
- **Voltmeter/time:**
Display average voltage of battery or time.
Under the normal display status, press "SET" button 0.5 second, it can switch "VOLTAGE" display mode or "CLOCK" display mode.
In time display mode, when the scooter is stationary, long press the "MODE" button more than 2 seconds, then it enters the time setting MODE, at this time press "MODE" button 1second, it can switch over setting mode (Hour→minutes tens digit→minute single digits).
Short press "SET" button once, figure add 1.
In setting display mode, long press the "MODE" button for more than 2 seconds, it can leave the setting mode.
- **Fault indicator light:**
If there is something wrong with the ECU, the warning light will light all the time.
- **Engine oil change warning lamp:**
It is used to indicate the oil exchange time, with lights, when the vehicle was driven about 1000 kilometers, indicator light will light up, warn the users to replace the oil.
After finish oil change, After the oil change, put the main switch in "ON", short press "SET" button two times in "OIL" mode, then the indicator light will go out.
- **ABS indicator light (for: ABS Model):**
Normally the ABS indicator light goes on when the ignition switch is turned on and goes off shortly after the scooter starts moving.
The ABS (Anti-lock Brake System) indicator light goes on when the ignition switch is turned on and goes off shortly after the scooter starts moving. If the ABS is normal, it stays off. If something is wrong with the ABS, the indicator goes on and stays on. When the indicator light is on, the ABS does not function but if the ABS fails, the conventional brake system will still work normally.
- **TCS indicator light (TCS Model) (For: XH12WZ-EU/KR):**
When the motorcycle is KEY ON, the information output from the gauges to the ECU enables the TCS function, Read TCS indicator ID information after gauges' self-inspection. After the TCS indicator is off (when the TCS has no fault). Press the "M" button to switch the TCS switch mode (TCS is displayed at the gauge's mileage). Long press the "S" button for more than 2 seconds, Perform ON or OFF switching. When the TCS is turned on, the indicator is off, and when the TCS is turned off, the indicator is on.
Note: After switching TCS ON or OFF, it is required to wait for 2 seconds before switching again (it is

not allowed to switch continuously and prevent the switch from being touched by mistake. When the vehicle speed is greater than 5KM/H, the instrument cannot switch ON or OFF.

Mileage Setting:

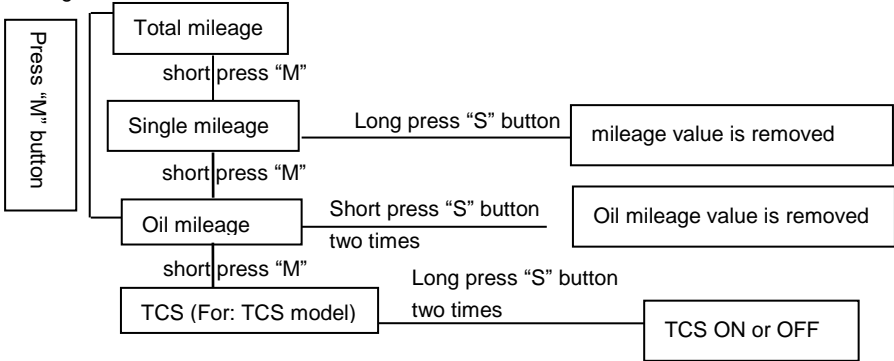

Clock Setting:

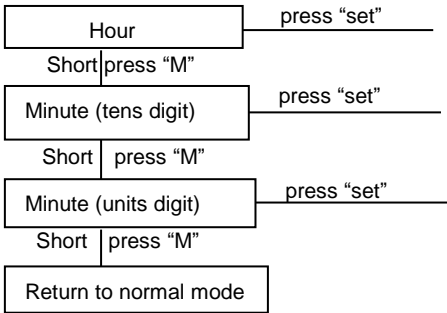

• **Switching kilometers and miles:**

In DOD mode Long press “S” and “M” button 2 ± 0.5 seconds or more, can toggle Metric and English.

IGNITION SWITCH

OPERATION OF IGNITION SWITCH §



“ON” position:

- Engine can be started in this position.
- Ignition switch key cannot be removed.



“OFF” position:

- Engine is shut off and cannot be started in this position.
- Ignition switch key can be removed.

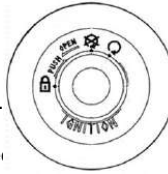

Smart key (remove the key after pressing the switch)

Keyless type

- Some models are equipped with intelligent lock.
- If the intelligent lock cannot be released under abnormal conditions, please turn on the switch and release it with the key.

OPERATION OF STEERING HANDLE LOCK SWITCH §



“Steering handle lock” position

- Turn the steering handle to left and insert the key into, press ignition switch key clockwise and then lightly turns it to left to the “lock” position.
- The steering handle is locked in this position.
- Ignition switch key can be removed.
- When unlocking, simply turn the key from the “LOCK” position to the “OFF” position.



CAUTION:

- Make sure to take the key away with you before you lock your seat.

OPERATION OF SEAT OPEN SWITCH§



- Left “OPEN” position: Insert your key into the ignition switch, and turn it to the left to open the seat.



CAUTION:

- Never operate the ignition switch key when the motorcycle is running. To turn the ignition, switch to “OFF” and “LOCK” position will shut off the electrical system and that may result in a dangerous accident. Therefore, the ignition switch can only be turned off after the motorcycle has been completely stopped.
- Always remove the key and be sure to take the key away with you after locking the steering handle before leaving your motorcycle.
- If ignition switch remains in the “ON” position for a prolonged period after the engine has been stopped, the battery’s capacity will be reduced and this may affect the engine’s start ability.
- Make sure to take the key away with you before you lock your seat.

§DESCRIPTION OF ANTI THEFT INTELLIGENT LOCK(for Intelligent lock model)§

1. **Set security : When motorcycle ignition lock is off (For: Generation 1 KEYLESS model)**

Silent alert : Press the mute key or lock key of the remote control once, the direction light will flash once, the lock will be locked, and it will enter the silent alert state after 3 seconds.

Set security : When motorcycle ignition lock is off (For: Generation 2 KEYLESS model)

Sound and light warning : Press the remote control once, the horn will sound a warning tone, the direction light will flash once, and the lock will be locked. After 3 seconds, it will enter the sound and light warning state.

Silent alert : Press the mute key of the remote control once, the horn will sound, the direction light will flash once, the lock will be locked, and it will enter the silent alert state after 3 seconds

2. **Remove anti-theft and automatic recovery alert (For: Generation 1 KEYLESS model)**

Press the release key of the remote control, the direction light will flash twice, the lock will be unlocked, and the alert will be released. (Normal unlocking) ° If the main switch is not turned on within 30 seconds, the alarm system will be regarded as false release and will automatically return to the original anti-theft alert state. (If you press the unlock key by mistake, it will be locked automatically)

careful : Press the release key twice in 2 seconds to completely release the alarm, and it will not automatically return to the alert state.

Remove anti-theft and automatic recovery alert (For: Generation 2 KEYLESS model)

Press the release key of the remote control, the horn will sound twice, the direction light will flash twice, the lock will be unlocked, and the alert will be released. (Normal unlocking)

If the main switch is not turned on or the vehicle does not sense vibration within 20 seconds, the alarm system will be regarded as false release and will automatically return to the original anti-theft alert state ° (silent alert or sound and light waning) (If you press the unlock key by mistake, it will be locked automatically)

careful : Press the release key twice in 2 seconds to completely release the alarm, and it will not automatically return to the alert state.

3. **Alert not set (For: Generation 1 KEYLESS model)**

Stop and turn off the engine in the release state (turn off the main switch), If the alarm is not set after 5 seconds, the horn will sound bi - bi - Bi, and the direction lights will flash three times.

In the released state: stop and turn off the engine (turn off the main switch). If the anti-theft warning is not set after 5 seconds, the direction light will flash three times. 30 seconds automatic locking and Enter silent alert. (If you forget to lock the engine, you will give an alarm)

Alert not set (For: Generation 2 KEYLESS model)

In the released state: stop and turn off the engine (turn off the main switch). 20 seconds automatic locking and enter silent alert. (If you forget to lock the engine, you will give an alarm)

4. **Main switch emergency alarm (For: Generation 1 KEYLESS model)**

In the anti-theft alarm state, if the switch lock is opened by force (main switch is on), the horn will give an

In the anti-theft alert state: When the switch lock (main switch on) is forced to turn without unlocking, the direction light will flash synchronously. You can press the remote control release key or turn off the switch lock to stop the alarm. (This operation is regarded as prying lock, so alarm is given).

Careful: When leaving the vehicle, make sure that the main switch is turned to "lock" and lock the direction handle.

5. Automatic lock for: Generation 1 KEYLESS model)

When the main switch is off : When the main switch is turned from off to lock, the lock will be locked automatically after one second, and then it will enter the sound and light warning state after three seconds. (The handle locks automatically)

In lock state : Press the release key of the remote control once, and if it does not exit lock within 15 seconds, it will automatically return to the alert state. (If you press the unlock key by mistake, it will lock automatically)

In the released state : When lock is turned off, it will lock automatically after 15 seconds.

Automatic lock (For: Generation 2 KEYLESS model)

When the main switch is off : When the main switch is turned from off to lock, the lock will be locked automatically after one second, and then it will enter the sound and light warning state after three seconds. (The handle locks automatically)

In lock state : Press the release key of the remote control once, and if it does not exit lock within 15 seconds, it will automatically return to the alert state. (If you press the unlock key by mistake, it will lock automatically) In lock state · Press the release key twice in 2 seconds. If it cannot be removed completely, it will automatically return to the original anti-theft alert state (sound and light warning state or silent alert state)

In the released state, When the main switch is turned from off to lock · and it will lock automatically after 15 seconds, and enter the silent alert state · Press the release key twice in 2 seconds to completely release the alarm, and it will not automatically return to the alert state.

6. Malicious operation of solenoid valve protection (For: Generation 1 KEYLESS model)

In 10 seconds, if the solenoid valve is operated continuously for 10 times, it is judged as malicious operation, and the system will automatically protect it. In the protection state, press the remote control host to respond normally, but the lock solenoid valve does not respond (does not act). After 15 seconds, it will automatically exit the solenoid valve protection and return to normal.

Malicious operation of solenoid valve protection (For: Generation 2 KEYLESS model)

In 10 seconds, if the solenoid valve is operated continuously for 10 times (The 10th forced lock and silent alert), it is judged as malicious operation, and the system will automatically protect it.

In the protection state, press the remote control host to respond normally, but the lock solenoid valve does not respond (does not act). After 15 seconds, it will automatically exit the solenoid valve protection and return to normal.

7. Alarm pause

When the vehicle is in the vibration alarm state: the alarm can be suspended by short pressing the fortification key, release key or mute key, and the original fortification state remains unchanged. (Press any key to remove the alarm without changing the alarm state)

8. Alarm mode (For: Generation 1 KEYLESS model)

trigger Alert state	First vibration trigger	Vibrate again in 15 seconds	Emergency alarm of main switch
silent alert state	The lights flashed three times	The lights flashed eight times	In the anti-theft alert, the switch is forced to open, and the main switch is opened to enter the periodic sound and light alarm

Alarm mode (For: Generation 2 KEYLESS model)

trigger Alert state	First vibration trigger	Vibrate again in 15 seconds
sound and light warning state	alarm three times	Acousto-optic alarm for 15 seconds (after 8 consecutive cycles, enter the sound and light warning state)
silent alert state	No alarm	No alarm

9.LED status (For: Generation 1 KEYLESS model)

state	LED status
Fortification	Flash 4 times every 1.5 seconds, and turn off after 5 seconds
relieve	Flash once every 1 second and turn off after 5 seconds
Main switch ON	Normally on for 5 seconds and then off
alarm	Flashing with alarm

9. SPECIFICATION (For: Generation 1 KEYLESS model)

1. Working voltage: 12V 2.Static current: average \leq 3.5ma 3.Working current: \leq 600A 4. Modulation mode: ASK
Working voltage of remote control: 3V 6. Horn sound level: 90-115db 7. Working frequency: 433.92mhz

10. PKE UNLOCK(For: Generation 2 KEYLESS model)

1. When the rotary handle of the main switch is in the "LOCK" position (the scooter is in the anti-theft alert state),when the remote control is within 3 meters from the main switch, press the unlock button on the remote control once, the main switch will flash five times and ring twice, then the main switch is unlocked. Rotate the handle of switch within 15 seconds, the handle can be rotated to the "OFF" or "ON" position. After 15 seconds, the main switch will be locked automatically.
2. When the rotary handle of the main switch is in the "LOCK" position(the scooter is in the anti-theft alert state),when the remote control is within 3 meters from the main switch, press down the main switch button or move the scooter (vibration detection), the main switch will flash five times, then the main switch is unlocked. Rotate the handle of switch within 15 seconds, the handle can be rotated to the "OFF" or "ON" position. After 15 seconds, the main switch will be locked automatically..

11. IMMO Induction unlocking(For: Generation 2 KEYLESS model)

When the battery power of the remote controller is too low to use, this function can be used to unlock) When the main switch is locked (the handle of switch is in the "LOCK" or "OFF" position), press the handle downward, place the remote control less than 1 cm from the immobilizer sensing area within 10 seconds (the immobilizer is near the main switch), and the switch will be unlocked automatically. After the switch unlocking when the remote control is close to the immobilizer sensing area(the immobilizer induction unlocking), if the handle is still in the "LOCK" or "OFF" position for long time, it will still return to the original anti-theft alert state automatically(sound-light alert or mute alert)

12. Malicious operation of PKE protection(For: Generation 2 KEYLESS model)

In 10 seconds ,if you press the PKE is operated continuously for 10 times, (the 10th time forced locking and entering the silent alert), it is judged as malicious operation .and the system will automatically PKE protection state for 15 seconds .In the protection state, Press the remote control host to respond normally .but the lock operation and PKE does not respond(does not act.) ,After 15 seconds ,it will automatically exit the PKE protection and return to normal.

CAUTION :

1. When using the spare key, insert and remove the key in the same gear °
2. When leaving the vehicle, make sure that the main switch is turned to "lock"
3. Please keep the spare key "key code" aluminum plate properly. If the key is lost, you can order a new spare key from the dealer with the "key code". If the key is not available, it may cause your car to fail to start.
4. Ensure the battery capacity \geq 8ah.
5. If the vehicle is not riding for a long time, the battery must be disconnected and the battery should be charged and maintained every month.
6. The effective distance of the remote control button must be more than or equal to 20 meters. Please avoid touching the remote controller within the effective distance to unlock the vehicle.
7. When the operating distance of the remote control is less than 10 meters, pay attention to replace the built-in battery of the remote control, and the battery specification must be consistent with sym factory specification.
8. Pay attention not to install other electronic components not approved by SCN, so as to avoid frequent abnormal power loss of vehicle battery.
9. Please do not directly expose the remote controller to the sun and rain.
10. In noisy and vibration environment, it is necessary to consider whether fortification is necessary to prevent battery power loss caused by long-time alarm.
11. The remote control battery is not in the three packs.
12. If the user disassembles the machine by himself or is damaged artificially, it is not covered by the warranty

§USE OF BUTTONS §

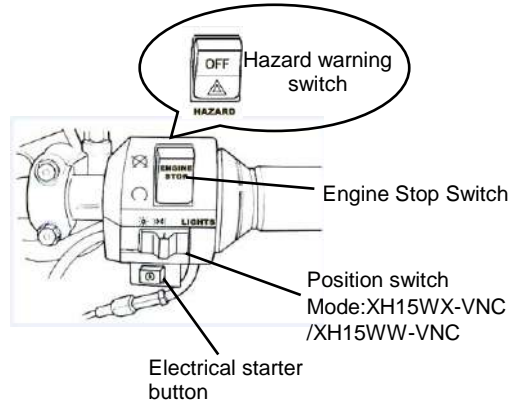
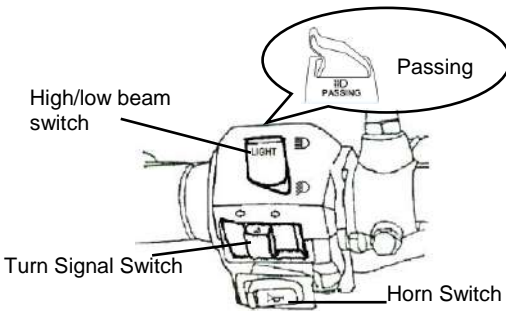

• Electrical starter button



this is a starting motor button (switch) for engine starting.

With the main switch “on”, press this button while holding the front or rear brake lever will start the engine.

⚠ CAUTION:

- Release this button immediately after engine has been started, and never press the button again to avoid damaging the engine.
- This mechanism is a safety design. The engine can only be started after the front or rear brake lever (pedal) has been applied.
- Do not use light system. Turn headlight and turn signal light to the “off” position when the engine is being started.

• High/low beam switch

This is the high and low beam of headlight switching switch. Press this switch to switch between high and beams.



This is for high beam.



This is for low beam. (please turn to low beam riding in city.)

• Hazard warning switch



When the switch is turned to this position as the engine is being started, the front and rear turn signal lights will flash.

• Engine Stop Switch



Switch to this position to turn off the engine when a state of emergency.



Switch to this position and the engine can be started.

• Passing switch



Turn ignition switch to the “ON” position and press this button down. Then, the high

beam of headlight will come on immediately to warn the driver of the vehicle ahead that you intend to overtake him/her. (For overtake, high beam indicator will come on at this time) This button will return to original position after releasing

• Engine start control switch

The switch button position is under seat.

“ON” position: Engine is locked and can not be started engine in this position.

“OFF” position: When the ignition switch is “on” position,, press electrical starter button while holding the front or rear brake lever will start the engine.

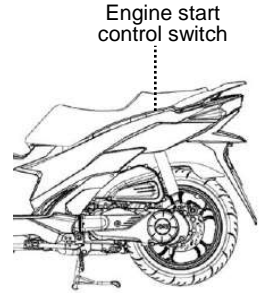

• Horn Switch



Press this button down when ignition switch is in the “ON” position, the horn will sound.

• Turn Signal Switch

Turn signal lights are used when turning left/right or changing lane.

Turn ignition switch to the “ON” position, and slide the turn signal switch to left or right . Then, the turn signal lights will flash.

To release, simply return the turn signal light button to the original position.



Left-side turn signal light flashing means you intend to make a left turn.



Right-side turn signal light flashing means you intend to make a right turn.

§STORAGE BOX§

- This box is located under the saddle.
- Maximum load capacity:10kg.
- Do not store valuables in the box.
- Make sure that the saddle has been locked completely after it was pressed down.
- Take out valuables before washing to avoid wetting these objects.
- Do not place thermal sensitive objects in the box because of engine’s heat and high temperature.

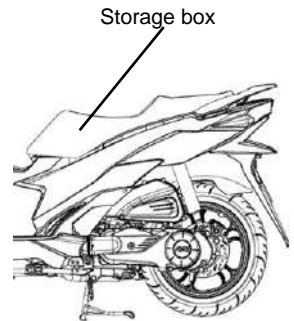

§SAFETY HELMET HOOKS

- Stop the scooter, and hook the safety helmet chin belt the hook.

CAUTION:

- Do not hang the safety helmet onto this hook when riding to avoid damaging motorcycle and losing safety helmet’s function.



§FUEL TANK CAP§

1. Insert the key into the seat lock and open the seat, and turn the fuel cap anticlockwise, then the cap can be removed.
2. Do not fill above the fuel upper limit when refueling.
3. Align the “△”mark on the cap with the “△”mark on the fuel tank, then turn the fuel cap clockwise and lock the seat.

CAUTION:

- Main stand should be put down on the ground, engine should be shut off and flames should be strictly prohibited to ensure safety when refueling.
- Do not fill above fuel upper limit when refueling. Otherwise, fuel will flow out through a hole on the cap that may damage the body's painting, in serious cases; it may cause a fire to burn down the motorcycle.
- Make sure the fuel cap has been tightened properly.

§BRAKES

Pull the right brake lever to operate the front brake.

Pull the left brake lever to operate the rear brake (ABS model).

Pull the left brake lever to operate the front and rear brake simultaneously (CBS model).

- Avoid unnecessary sudden braking.
- Use front and rear wheel brakes simultaneously when braking.
- Avoid brake continuously for a long period of time because that may overheat the brakes and reduce its braking efficiency.
- Slow down and brake early when riding in rainy days on slippery roads. Never apply the brakes suddenly to prevent skidding and falling.
- Using only the front brake or the rear brake increases the risk of falling because the scooter is tend to pulled to one side.
- Even in motorcycles equipped with ABS, braking during cornering may cause wheel slip. When turning a corner, it is better to limit braking to the light application of both brakes or not to brake at all. Reduce your speed before you get into the corner.

CBS model

For Front Wheel And
Rear Wheel

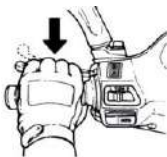

For Front Wheel



ABS model

For Rear Wheel

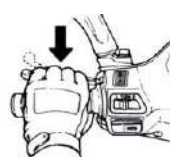

For Front Wheel



《Engine Brake》

Return the throttle valve handle back to its original position, and apply engine brake.

It is necessary to apply brake both for front wheel and for rear wheel intermittently when riding on a

long or stiff slope.

IMPORTANT POINTS AND CAUTIONS FOR STARTING ENGINE

CAUTION:

- Please check the oil and fuel volume are adequate or not before starting the engine.
- To start the engine the main parking stand must be firmly on the ground and the brake is applied on the rear wheel to prevent the motorcycle from moving forward suddenly.

1. Turn ignition switch key to the "ON" position.
2. Apply hand (foot) rear wheel brake.
3. Do not accelerate, press starter button when the brake is applied.

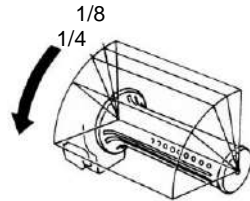
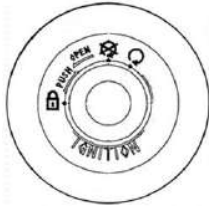

[We care for you! Before drive off, keep the hand brake applied on the rear wheel.]

CAUTION:

- In order to avoid damaging the starter motor, please do not press the starter button continuously over 15 seconds.
- If engine still can not be started after pressing starter button over 15 times, stop and wait for 10 seconds before start it again.
- It is harder to get the engine started after the motorcycle has been left idle for a long time or after refueling only after the fuel has been depleted. Then, it is necessary to press starting lever or starter button several times, and keep the throttle valve handle at the close position to start the engine.
- It may need several minutes to warm up engine if it is a cold start.
- Exhaust contains harmful gases (CO), therefore please start the engine at a well ventilated place.

7. THE BEST WAY TO DRIVE OFF

- Turn on the turn signal light before moving, and make sure no vehicle is coming from behind. Then, drive off.

§THE CONTROL OF THROTTLE VALVE HANDLE §

Acceleration : To increase speed. When riding on an inclined road, turn the throttle valve handle slowly to allow the engine to output its power.

Deceleration : To decrease speed.

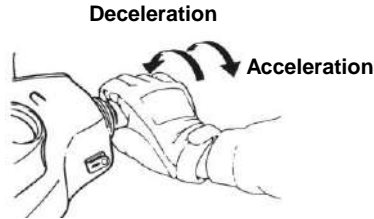

§PARKING METHOD §

- **When approaching the parking lot:**

1. Turn on the turn signal light early, and pay attention to the vehicles in front, from rear, left and right, then take the inner lane and approach slowly.
2. Return the throttle valve handle back to its original position, and apply brakes in advance. (Brake light comes on when braking to warn drivers of vehicles behind.)

- **When stop completely:**

3. Press the turn signal switch back to its original position, and turn the ignition switch key to the “OFF” position to shut off the engine.
4. Get off the scooter from left side after the engine has been stopped, and select a parking place where the scooter will not interfere with traffic and the ground is level, then put down scooter’s main parking stand.
5. Hold the steering handle with your left hand, and hold down the front end of saddle or hold the parking handle on the lower-left side of saddle with your right hand.
6. Press the main parking stand with your right foot, put down the main parking stand firmly on the ground.

To remind you: Lock the steering handle and remove the key after parking to prevent the scooter from being stolen.

 **CAUTION:**

- Park your motorcycle at a safe place where it will not interfere with traffic.

8. INSPECTION AND MAINTENANCE BEFORE RIDING

(Please refer to the components location diagram for the following components.)

§ROUTINE INSPECTION §

Check Items		Check Key Points
Engine Oil		Is there enough engine oil?
Fuel		Is it enough? Is it Octane 90 or above
Brake	Front	Braking condition? (Brake lever free play: 10~20mm)
	Rear	Braking condition? (Brake lever free play: 10~20mm)
Tires	Front	Is tire pressure normal? (Standard: 1.75kg/cm ²)
	Rear	Is tire pressure normal? (Standard: 2.0 kg/cm ² for 1 person, 2. 25 kg/cm ² for 2 persons)
Steering Handle		Does the handle vibrate abnormally or is difficult to turn?
Speedometer, lights, and rearview mirror		Is it operated properly? Do lights come on? Can it be seen clearly from behind?
Tightness of Main Components		Are screws, nuts loosen?
Abnormal Points		Do the previous troubles still exist?

CAUTION:

- If any problem founded during routine inspection, correct the problem before using the motorcycle again, have your motorcycle checked and repaired by the “**SYM dealer or authorized service personnel**” if necessary.

§ENGINE OIL INSPECTION AND CHANGE §

• INSPECTION:

1. Use the main parking stand to support the scooter on a level ground, remove the dipstick after engine stopped for 3~5 minutes. Wipe oil off the dipstick and then insert it into the guide tube again (Do not rotate it.)
 2. Remove the dipstick and check whether oil level is in between the upper and lower marks.
- Add oil to upper limit if oil is under the lower limit. (Check cylinder, crankcase...etc for leakage.)

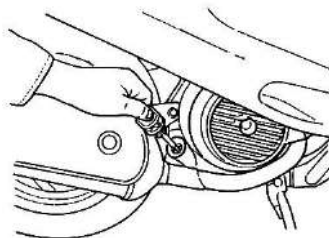

OIL CHANGE:

- Change engine oil after the first 300km, and change the engine oil every 3000km thereafter.
(See the manual page29 for further details.)
- In order to maintain the engine's maximum performance, check whether the engine oil is enough every 1000km. Add oil to upper limit if the engine oil has been found to be inadequate.
- Engine Oil : Use (API) SJ MA10W-30 grade or better engine oil.(especially suggest USE SM 10W 50)
Otherwise, damage will not be covered by warranty.
- ※ Recommended Oil: **SYM Genuine 4X OIL.**
- Oil Capacity : 1.00 Liter (0.80 liter for routine change).
- (See the manual page specification for further details)
- Use SAE 5W-40 when outside temperature is below 0°C.

【Oil Filter Cleaning】

The oil filter nut assembly of the element, and remove the element. Remove the foreign materials from the element by using a gasoline or air spraying gun.

⚠ WARNING:

- Oil level will not be correct when checking the oil level with the motorcycle parked on an unlevelled ground or immediately after the engine stopped.
- Engine and exhaust pipe are hot right after engine stopped. Pay special attention not to get burned when checking or replacing engine oil.
- If the oil lever approach lower limit again after refilled, check the engine for leaks and refill it again.
- Keep away from spark and flames when refilling the oil.

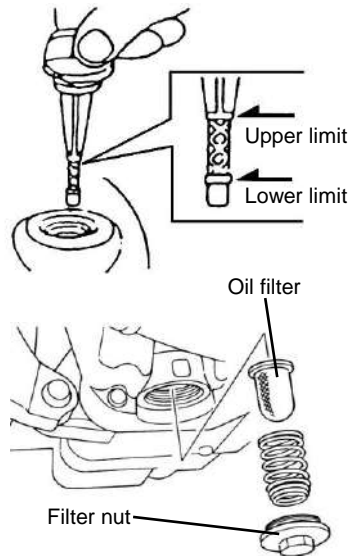

Avoid oil emulsification

- Warming up at regular intervals
- Warm car runs in a minute every time
- At least run 10 km once a month
- Replace oil when 3 months or 3000km

§FUEL INSPECTIONS

- Turn main switch key to "ON" position, and check fuel gauge's needle range to make sure there is enough amount of fuel in the fuel tank.
- This scooter's engine is designed for using the unleaded fuel of Octane 90 or above.
- Firmly secure the main stand on the ground, shut off the engine and keep flames away from the scooter when refueling.
- Do not fill above fuel upper limit lever when refueling.
- Make sure the fuel tank cap had been tighten properly.

§TRANSMISSION OIL INSPECTION AND CHANGE§ INSPECTION:

- Use the main stand to support the scooter on a level ground, after the engine stops, wait for 3~5 minutes. Remove the transmission oil infusion bolt, put a measuring glass under the drain bolt, and remove the drain bolt. Let the oil flows into measuring glass and check for decreased or not.
(at disassembly:190c.c./at change:180c.c.)

OIL REPLACEMENT:

- Stop the engine and use the main stand to support your scooter on a level ground. Remove the infusion bolt and drain bolt, drain out the oil.
- Install the drain bolt and tighten it. Fill new transmission oil (180c.c.), and install the infusion bolt and tighten it. (make sure that bolts are tightened and check that there's no leakage.)

§INSPECTION AND ADJUSTMENT OF BRAKE FREE PLAYS

INSPECTION: (Brake lever free play must checked with the engine shut off.)

- Brake lever and pedal free play for front and rear wheels.
 - ◆ If checking the hand-braking lever for front wheels, its free play (the stroke of hand-braking lever from no braking to initial braking) should be 10~20mm. It is abnormal if the feel is spongy when holding the hand-braking lever forcefully.
 - ◆ If checking the foot-braking pedal for rear wheels, its free play (the stroke of foot-braking pedal from no braking to initial braking) should be 20~30mm. It is abnormal if the feel is spongy when press the foot-braking pedal forcefully.

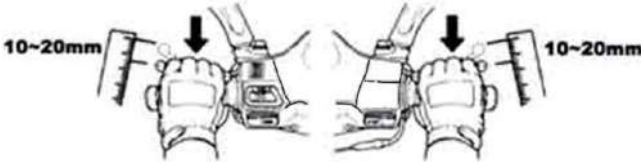

For rear wheel

For front wheel

§DISK BRAKE INSPECTIONS(Applicable for model equipped with disc brake.)

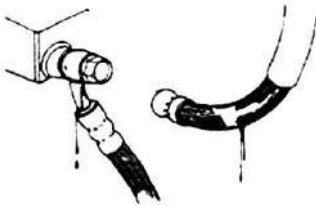

(leak, damaged, looseness of brake line)

- Visual check brake lines for leakage, or damage, check brake lines connections for looseness using a wrench or similar tool, and check whether steering handle vibration in driving, or any parts' interference may have damage the brake lines. If so, bring your scooter to your SANYANG dealer for repairing or service.

⚠ CAUTION:

- Please drive your motorcycle on a dry road surface slowly and operate front and rear brakes in order to find out if there is any malfunction so as to ensure the motorcycle is at optimum condition and safe ride.

(Checking front brake lining)

- check the brake from behind the brake caliper. The brake pad must be replaced with new lining when the brake pad wear limit reaches the brake disk.

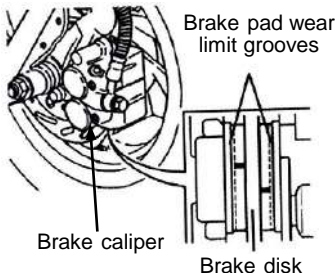

(Checking oil quantity in brake oil reservoir)

- Park the scooter on a level ground, and check if fluid level is under the "LOWER" mark. Recommended Brake Fluid: WELL RUN BRAKE OIL (DOT 3).

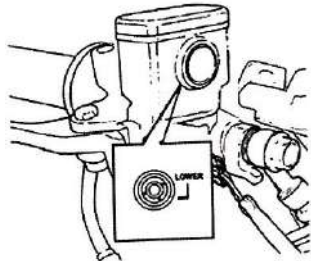

(Replenishment of front wheel brake fluid)

1. Loosen the screws and remove the master cylinder cover.
2. Wipe clean foreign materials, dirt around the reservoir, being careful not to let foreign materials fall into the reservoir.
3. Remove the diaphragm plate and the diaphragm.
4. Add brake fluid to upper lever.
5. Install the diaphragm plate and the diaphragm, and install the master cylinder cover.
6. please note the diaphragm direction, and do not let foreign materials fall into the reservoir. And tighten the master cylinder cover securely.

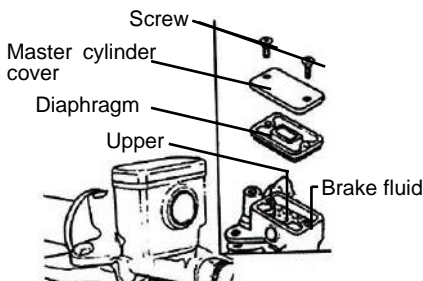

⚠ CAUTION:

- To prevent chemical reaction, please do not use brake fluids other than those recommended.
- Do not fill above the upper limit when adding brake fluid and avoid dropping on painting or plastic components to prevent damage.

§ THROTTLE VALVE HANDLE CLEARANCE ADJUSTMENT §

- Correct clearance allows throttle valve handle to rotate 2~6mm.
- Loosen the lock nut first, then turn the adjust nut to adjust. Tighten the lock nut securely when finished.

Check Items:

1. Check throttle valve cable to see if it can be moved smoothly from a closed position to a wide open position.
2. Rotate steering handle from side to side to check if the throttle valve cable is interfered.
3. Check to see if the throttle valve cable is obstructed by other cables preventing it from being operated smoothly.

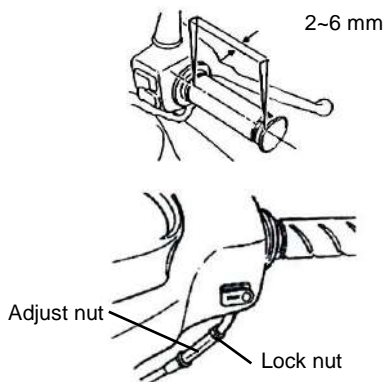

§ INSPECTION AND MAINTENANCE OF BATTERY §

- The scooter is equipped with a maintenance-free type battery, so it is unnecessary to check and add electrolyte. Have your scooter checked by SYM Authorized Dealer or Franchised Dealer should any abnormality is found.

(Cleaning of battery terminals)

- Remove the battery terminals and clean if there are dirt and corrosion on them.
- Battery removal procedures are as follows:
Turn ignition switch to the "OFF" position, then remove negative cable screw firstly and disconnect the negative cable. Then, remove positive cable screw and positive cable.

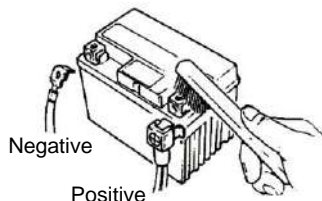

⚠ CAUTION:

- Clean the battery posts with warm water if the posts are eroded and have some white powders on them.
 - If there is an obvious erosion on the terminals, disconnect the cables, and then clean the erosion off with a steel brush or a piece of sandpaper.
 - Install battery cable after cleaning and apply a thin coat of grease on the terminals.
 - Install battery in reverse order of removal.
- The scooter is equipped with a maintenance-free type battery, so it is unnecessary to check and add electrolyte. Have your scooter checked by SYM Authorized Dealer or Franchised Dealer should any abnormality is found.

⚠ CAUTION:

- This is a closed type battery. Never remove the caps.
- In order to prevent electric leakage and self-discharge when the battery sits idle for long periods. Remove battery from motorcycle, store it in well-ventilated and dimly lighted place after the battery has been fully charged. Disconnect battery's negative cable if the battery is still kept on the motorcycle.
- If the battery needs to be replaced, replace with a same closed-type battery (Maintenance-Free).

§TIRE INSPECTION §

- Tires should be checked and inflated with the engine shut off.
- If a tire's ground contacting curve is abnormal, check it with an air pressure gauge and inflate it to the specified pressure.
- Tires pressure must be checked with an air pressure gauge when cold.

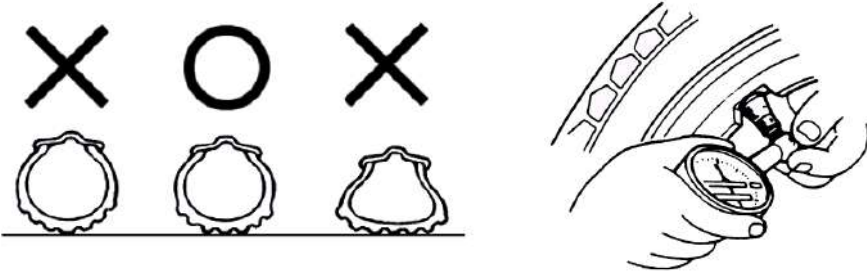

PLEASE REFER TO SPECIFICATIONS FOR STANDARD TIRE PRESSURE

Foreign materials
(nails or small
stones)

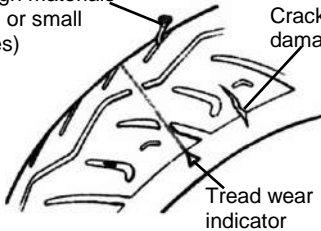

- Visual check tires for frontal and lateral side walls for crack or damage.
- Visual check tires for any nails or small stones wedged in the tread.
- Check the “tread wear indicator” condition to see if tread groove depth is insufficient.
- A tire with a wear bar showing is worn out and should be replaced immediately.

⚠ CAUTION:

- Abnormal tire pressure, wear, or crack is the most important cause that results in the loss control of the steering handle and a punctured tire(s).

§STEERING HANDLE FRONT SHOCK ABSORBERS INSPECTION §

- Perform this check with engine shut off and ignition switch key removed.
- Visual check front shock absorbers for damage.
- Operate steering handle up and down, and check front shock absorbers for noises due to bends.
- Check the bolts and nuts of front shock absorbers with wrenches for tightness.
- Shake steering handle up & down, left & right, and front & rear to check if it is loosen, has too much resistance and pulls to one side.
- Check steering handle if it is being pulled too tight by the brake cables.
- Take your scooter to SYM Authorized Dealer or Franchised Dealer for a check or adjustment if any abnormal conditions are found.

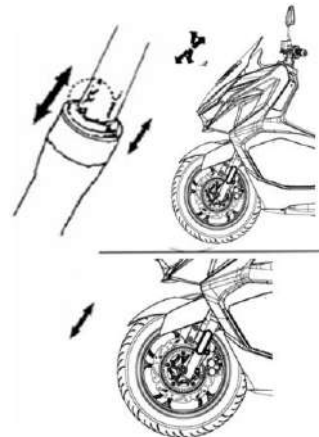

§CHECKING AND CHANGING FUSES §

Turn off ignition switch, and check fuses if they are intact. Replace the blown fuse with a new one having the same specified amperage rating (10A/15A*2/20A). Using a fuse of more than (10A/15A*2/20A) amperes, a brass or iron wire to replace a blown fuse is strictly prohibited to avoid damaging the electrical system and the circuit. **(see the manual page specification for further details)**

- Remove the storage box, and you'll find the fuse holder near battery.
- Open the fuse box cover, and pull out the fuse. Check it for damage or broken.
- Fuses must be firmly secured with wire connectors when replacing. Loose connections will result in overhead and damage.
- Use only parts having the specified specification to replace electrical components such as light bulbs. Using parts not having the specified specifications for replacement may cause the fuse to blow and over-discharge the battery.
- Avoid spraying water directly on or around fuse box when washing the scooter.
- If the new fuse burn out quickly again, please check the faulty reason before replace it again. Take your scooter to your dealer for an inspection if a fuse is blown by unknown causes.

【REMOVE】

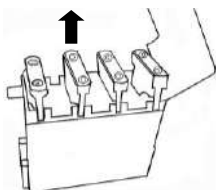

【INSTALLATION】

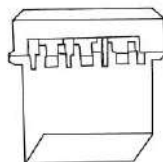

§CHECKING THE TURN SIGNAL LIGHTS AND HORN §

- Turn the ignition switch key to the "ON" position.
- Turn on the turn signal light switch, and make sure that the front & rear and left & right signal lights flashes and also check if the warning buzzer sounds.
- Check turn signal light covers if they are dirty, crack, or loosen.
- Press horn button to check if it works.

⚠ CAUTION:

- Specified specification bulbs should be used for turn signal lights. Otherwise, the normal operation of turn signal lights will be affected.
- Turn on the turn signal light before turning or switching lane to warn driver of vehicles behind.
- Turn off the turn signal light immediately by pressing its button down after using. Otherwise, the flashing of twin signal lights may confuse the drivers of vehicles behind.

§CHECKING THE FRONT AND REAR LIGHTS §

- Start engine and turn on the head lamp switch. Check if head lamp and rear lamp come on.
- Check the brightness and direction of front light by wall to see if it is correct.
- Check the head lamp cover if it is dirty, crack, or loosen.

§CHECKING THE BRAKE LIGHT §

- Turn the ignition switch key to the "ON" position, hold the hand-braking levers for front and rear wheels. Check if the brake lights come on.
- Check the brake light cover if it is dirty, crack, or loosen.

⚠ CAUTION:

- Use only specified specification bulbs, do not use bulbs with different specifications to avoid damaging electrical system, burning out bulbs, and discharging the battery.
- Do not modify or add other electrical components to prevent over load or short circuit which may result in a fire and burn down the motorcycle in serious cases.

§CHECKING FOR FUEL LEAKAGES§

- Check fuel tank, fuel cup, fuel hose, carburetor (if had)for leakage.

§CHECKING THE LUBRICATION OF BODY'S VARIOUS MECHANISMS§

- Check the body's pivot points if they have enough lubrication.
(for example, the pivot points on the main stand, the side stand, and the brake lever...etc.).

§CHECKING THE SPARK PLUGS§

- Remove the cap of spark plug cable .
- Check the electrode if it is dirty or fouled by carbon deposits.
- Remove the carbon deposits on the electrode with steel wire, and clean the spark plug with gasoline, then, wipe dry with a rag.
- Check the electrode, and adjust its gap to 0.6~0.7 mm. (Check it with a feeler gauge)
- Hand tight the spark plug as far as it can go and then tighten it another 1/2~3/4 turns with a wrench.
-

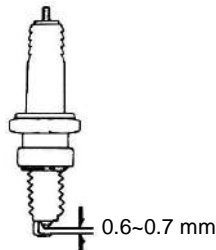

⚠ WARNING:

The engine is very hot after running. Pay attention not to get burned.

- ※ Use only spark plugs suitable for the engine specifications of this motorcycle recommended by the manufacturer. (Refer to specifications.)

§CHECKING THE AIR CLEANERS§

《DISASSEMBLE PRCEDURE》

1. Remove tapping screws from air cleaner cover.
- 2.Remove the air cleaner cover, remove the element screws , then remove filter element. .
- 3.Take the element out and clean it. (Refer to maintenance schedule.)

Screws

Element

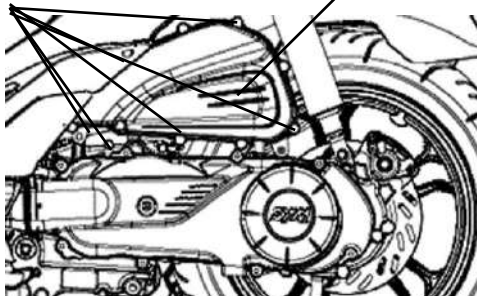

《DISASSEMBLE PRCEDURE》

- Assemble the air cleaner in reverse order of disassemble.

⚠ CAUTION:

- Dust deposit is one of the major causes of reducing output horsepower and increasing fuel consumption.
- Change the air cleaner element more frequently to prolong the engine's service life if the motorcycle is driven on dusty roads very often.
- If air cleaner is installed improperly, dust will be absorbed into cylinders, which may cause a premature wear and reducing output power and engine life.
- Be careful not to soak the air cleaner when washing the motorcycle. Otherwise, it will cause engine hard to start.

9. HEN THERE IS AN ABNORMAL CONDITION OR A TROUBLE

§DIAGNOSIS WHEN ENGINE DOES NOT START §

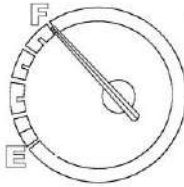
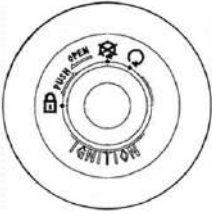

For rear wheel

For front wheel

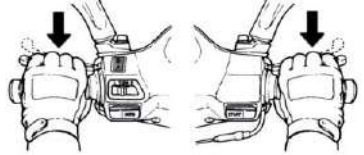

(1). Has the ignition switch key been turned to the "ON" position?

(2). Is there enough fuel in the fuel tank?

(3). Is the rear or front wheel brakes applied when pressing starting button?

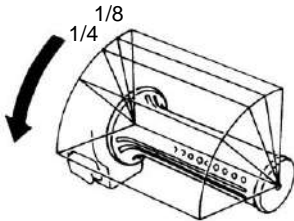

(4). Do you rotate the throttle valve handle while pressing starting the button?

(5). Turn the ignition switch key to the "ON" position, and press horn button down, if the horn does not sound, the fuse may have been blown.

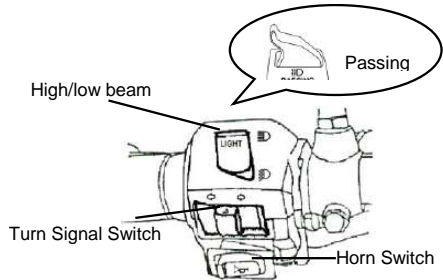

【 Have your scooter checked by SYM authorized dealer or franchised dealer immediately if there are no problems with the above items and engine still can not be started. 】

10. SUGGESTIONS ON ENGINE FUEL

- This scooter is designed to use UNLEADED gasoline of Octane No. 90 or higher.
- If the scooter is operated in high altitude (where the atmosphere pressure is lower), it is suggested that the air/fuel ratio should be readjusted to maximize the engine performance.

11. TRANSMISSION OIL

- Recommended OIL: GENUINE SYM GEAR OIL (SAE 85W-140)

12. CAUTIONS FOR RIDING SCOOTER

1. Raise the scooter with the main stand, and sit on the saddle.
Push the scooter forwarding to raise the main parking stand.

 **CAUTION:**

- Never rotate the throttle valve handle at will to increase the engine RPM before driving off.

2. Get on the scooter from the left side, and sit on the saddle properly, keep your right feet firmly on the ground to prevent the scooter from falling.

 **CAUTION:**

- Apply brake on the rear wheel before driving off.

3. Rotate the throttle valve handle slowly, and then the scooter will begin to move.

 **CAUTION:**

- Rapidly rotate the throttle valve handle or release the clutch lever may cause the motorcycle moving forward suddenly and it is very dangerous.
- Make sure the side parking stand is spring back completely before driving off.

[Do not use the brake suddenly and make a sharp turn]

- Rapid braking and sharp turning will cause slip and fall.
- Rapid braking or sharp turning will cause slipping, lateral slipping, or fall especially in rainy days when the road is wet and slippery.

[Drive with extreme caution during rainy days]

- The brake distance in rain day or on wet road will longer than that on a dry road. Therefore, slow down and prepare to apply the brake earlier.
- The throttle valve handle should be released, and the brakes should be properly applied as it is needed while reducing the speed when going down a slope.

§Anti-lock brake systems§(For ABS mode)

ABS is designed to help prevent the wheel from locking up when hard brakes are applied while running straight. The ABS automatically regulates brake force. Intermittently gaining gripping force and braking force helps prevent wheel lock-up and allows stable steering control while stopping.

Brake control function is identical to that of a conventional motorcycle. The brake lever is used for the front brake and the brake pedal for the rear brake.

Although the ABS provides stability while stopping by preventing wheel lock-up, remember the following characteristics:

- ABS cannot compensate for adverse road conditions, misjudgement or improper application of brakes. You must take the same care as with motorcycles not equipped with ABS.
- ABS is not designed to shorten the braking distance. On loose, uneven or downhill surfaces, the stopping distance of a scooter's with ABS may be longer than that of an equivalent motorcycle without ABS. Use special caution in such areas.
- ABS will help prevent wheel lock-up during straight-up braking, but it cannot control wheel slip which may be caused by braking during cornering. When turning a corner, it is better to limit braking to the light application of both brakes or not to brake at all.. Reduce your speed before you get into the corner.
- The computers integrated in the ABS compare vehicle speed with wheel speed. Since non-recommended tires can affect wheel speed, they may confuse the computers, which can extend braking distance.

CAUTION:

ABS cannot protect the rider from all possible hazards and is not a substitute for safe riding practices. Be aware of how the ABS system operates and its limitations. It is the rider's responsibility to ride at appropriate speeds and manner for weather, road surface and traffic conditions.

§TCS system§(For TCS mode)

TCS uses the control unit to detect the speed of the front and rear wheels. When the motorcycle starts or accelerates, if the speed difference between the rear wheel and the front wheel is detected to be too large, the control unit immediately judges that the driving force is too large, and immediately reduces the torque output of the engine by adjusting the ignition angle or cutting off the fuel, reducing the driving force, thereby reducing the slip rate of the rear wheel.

TCS, traction control system. Its purpose is to control the output torque of the engine to avoid or reduce the rear wheel slip when the motorcycle starts and accelerates, so as to maintain the stability of the motorcycle's driving direction.

The driver's control of the motorcycle is essentially to control the force between the tire and the road, but the force between the wheel and the road is limited by the adhesion characteristics between the tire and the road. When the force between the tire and the road is close to or reaches the adhesion limit, such as when the motorcycle starts or accelerates, if the road adhesion coefficient is small, such as snow, ice or wet muddy roads, the driving torque of the motorcycle will often exceed the adhesion limit between the tire and the road, resulting in excessive rear wheel slip, which not only reduces the driving performance of the motorcycle, increases tire wear, and increases the load on the transmission system and the driver, it increases fuel consumption and damages the controllability, stability and safety of the motorcycle. Therefore, reasonable adjustment of the force between the motorcycle tire and the road is of great significance for improving the active safety of the motorcycle.

14. COOLING SYSTEM INSPECTION

(Check the cooling system for leakage)

1. Support vehicle with main stand on a level ground.
2. Check radiator and piping for leakage.
3. Check the ground where the vehicle is parked for water dripped from the vehicle.

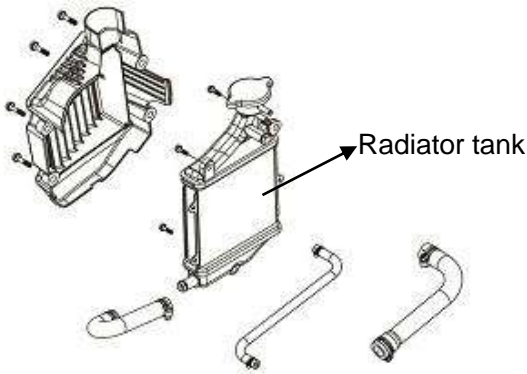

REPLENISHMENT OF COOLANT .

- Support vehicle on a level ground in a straight up position.
- Open the tank cover
- Open the reserved tank cover, add coolant to fill
- If coolant level drops too low, it may indicates there is something wrong with the coolant system.
- To avoid radiator getting rusty, do not use unknown brand coolants

Agent concentration: 50%

Radiator tank coolant capacity:430ml;

Reserved tank coolant capacity: 75-150ml.

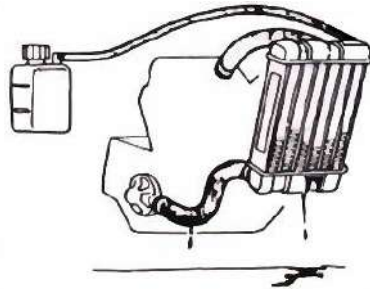

⚠ CAUTION:

- Use soft water when mixing coolants.
- Please pay attention to using poor quality coolant may shorten the service life of the radiator.
- Coolant should be changed once a year normally.
- Add coolant to reserved tank.
- Cooling system maintenance can work on the vehicle.
- Do not coolant coating body cover surface
- After the maintenance of the system, confirm the cooling system has no leakage.
- When the engine is warm, do not open the radiator tank cover, high temperature of the coolant will cause burns, the maintenance of cooling system can be carried out before the engine cooled out.
- Please refer to table for the concentration and temperature of the coolant when the air temperature is below zero.

A reference table for anti-freeze concentration percentages under different temperatures

- Proper anti-freeze percentages for different frozen temperatures are as follows:

Anti-freeze percentage	Frozen temperature	Remark
20%	-8	50% concentration is used for all scooters before delivery to ensure the effectiveness of anti-freeze.
30%	-15	
40%	-24	
50%	-36	

- If the specified anti-freeze is unavailable, use an equivalent with the same high quality.
- Increase radiator maintenance intervals when the weather is extremely cold.

15. PERIODICAL MAINTENANCE SCHEDULE

Item	Check Items	Maintenance kilometer	300KM	Every 1000KM	Every 3000KM	Every 6000KM	Every 12000KM	Remarks
		Maintenance Interval	NEW	1 Month	3 Months	6 Months	1 Year	
1	Air cleaner element (Remark)	I	I	C		R(paper)	R(sponge)	
2	Air cleaner	I	I					
3	Oil filter (Screen)	C	C			C		
4	Engine oil(air- cooling model)	R		Inspection for every 1000KM ,Replacement for every 3000KM				
5	Engine oil(water- cooling model)	R		Inspection for every 1000KM ,Replacement for every 5000KM				
6	Fuel pump filter	I		Replacement for every 10000KM				
7	Tire, pressure	I	I					
8	Battery	I	I					
9	Spark plug	I			I		R	
10	Cooling system			Check every 10000 km				
11	Coolant level			Check every 10000 km				
12	Coolant, water hoses and o-rings			Replacement for every 3 years				
13	Carburetor (idle speed)	I	I			I		
14	Steering bearing and handles	I	I		I			
12	Check transmission for leakage	I	I					
13	Check crankcase for leakage	I	I					
14	Transmission oil	R		Replacement for every 5000KM(5 Months)				
15	Drive belt/roller					I	R	
16	Fuel tank switch and lines	I	I		I			
17	Throttle valve operation and cable	I	I					
18	Engine bolts and nuts	I	I		I			
19	Cylinder head, cylinder, and piston					I		
20	Exhaust system/cleaning carbon					I		
21	Cam Chain/ignition time	I	I		I			
22	Valve clearance	I	I			I		
23	Shock absorbers	I	I			I		
24	Front/rear suspension	I	I			I		
25	Shock tension rod			Inspection every 10000KM,Replacement every 30000KM				
26	Main/side stands	I	I			I/L		
27	Crankcase Blow-by system(PCV)	I	I		I			
28	Clutch disk					I		
29	Brake mechanism/brake lining (pad)	I	I	I				
30	Bolts/nuts for each components	I	I	I				
31	Coolant			I	I		R	

☆ The above maintenance schedule is established by taking the monthly 1000 kilometers as a reference which ever comes first.

※ Have your scooter checked and adjusted periodically by your SYM Authorized Dealer or Franchised Dealer to maintain the scooter at the optimum condition.

Code: I ~ Inspection, cleaning, and adjustment R ~ Replacement

C ~ Cleaning (replaced if necessary)

L ~ Lubrication

Remark: 1. Clean or replace the air cleaner element more often when the scooter is operated on dusty roads or in the Heavily- polluted environment.

2. Maintenance should be performed more often if the scooter is frequently operated in high speed and after the scooter has accumulated a higher mileage.

【 Notes in the remarks are used to indicate the applicable models. 】

16. SPECIFICATION

Item	Model Specification	JET X 150
Length		2000±20 mm
Width		760±10 mm
Height		1115±20mm
Wheel base		1350±20mm
Net Weight		140±6kg (front 57±3kg rear 83±3kg)
Model		Single cylinder,4- stroke engine, liquid cooling
Fuel required		Unleaded gasoline
Compression ratio		11±0.2 :1
Maximum HP		12.3kw/8000 rpm
Maximum torque		12.0N.m/6000 rpm
Valve clearance: IN/EX		0.12mm/0.12 mm
Starting methods		Electrical starter
Front shock absorber		Telescopic fork
Rear shock absorber		Dual shock
Transmission		C.V.T.
Front tire		100/90-14
Rear tire		110/80-14
Rim type		Aluminum
Tire pressure		Front: STD 2.00 kg/cm ² , Rear: STD 2.00kg/cm ² for 1 person, 2.25kg/cm ² for 2 persons
Front brake		Disk type
Rear brake		Disk type
License light		12V 5W
Headlight deep/main beam		12V 35.7W/21.2W
Position Lamps		12V 2.5W
Taillight /Stoplight		12V 1.3W/8.5W
Turn signal light front/rear		12V 2.22W *2 /12V 2.2W*2
Engine oil capacity		1 L (0.80 L for change)
Transmission oil capacity		190c.c (180c.c for change)
Fuel tank capacity		7.5±0.5L
Fuse		10A*1&15A*2&20A*1
Spark plug		CR7HSA
Battery capacity		12V 7Ah
Air cleaner		Paper type

CAUTION: specifications or equipment are subject to change without notice.